



STRUCTURE ID: 401000

Precast Concrete 3'-0" Wide  
**Power Trench**



Precast Concrete 3'-0" Wide Power Trench :: STRUCTURE ID : 401000

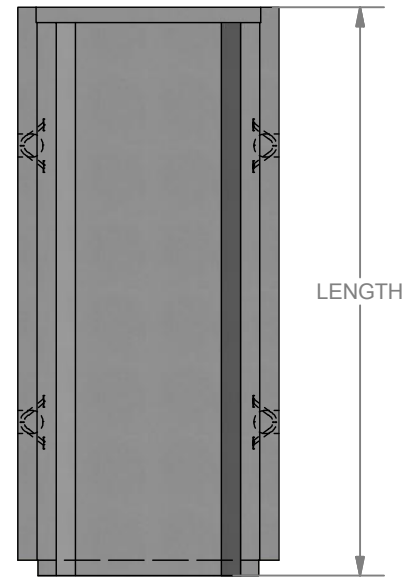
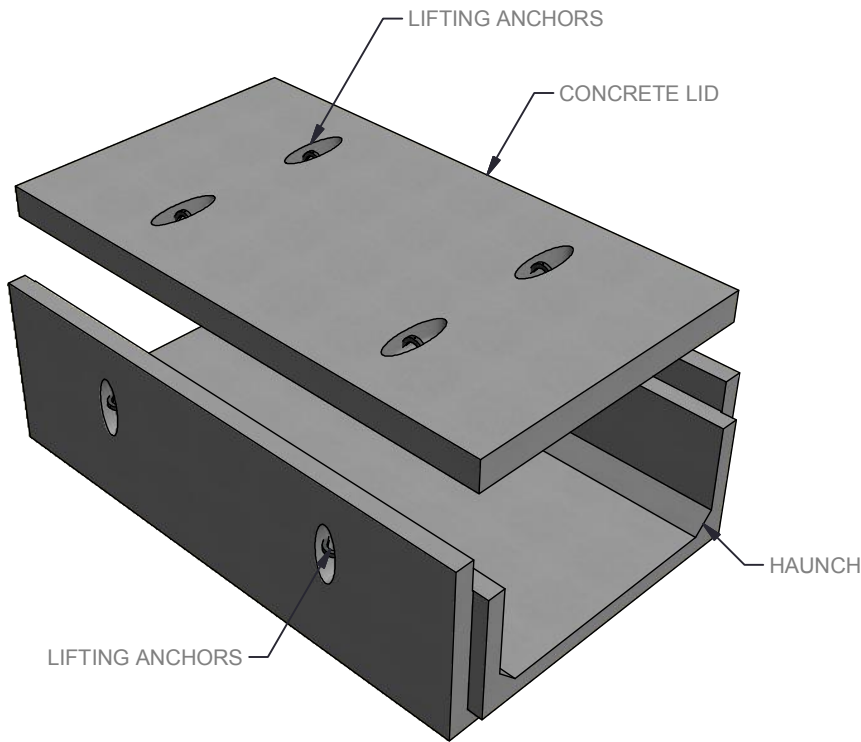

**PLAN VIEW (BODY)**



**ELEV. VIEW**

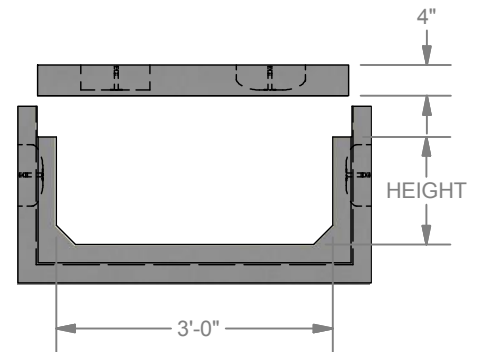

### STANDARD TRENCH FEATURES

- Trench and Cover are Designed for HS-20 Loading (32,000 lbs Axle Load)
- Concrete Cover (shown)
- Threaded Bolt Inserts Cast In Wall for Mounting Equipment (shown)
- Cable Tray Slots in Walls as Needed (shown)
- Cast In Pipe as Needed (shown)
- Chamfered Edges for Safe Installation & Quality

### TRENCH OPTIONS

- Unistrut Cast Into Walls
- Terminators Cast Into Walls
- Thinwall Knockouts
- Non-Metallic Racking
- Plastic Coated Racking
- Cast In Grounding Lug
- Galvanized Steel Cover or Grating in lieu of Concrete Cover

**LOCKE**  
SOLUTIONS

PROUDLY BASED IN  
HOUSTON, TEXAS

T : 832-804-7062  
F : 832-804-7071  
E : info@lockesolutions.com

[LOCKESOLUTIONS.COM](http://LOCKESOLUTIONS.COM)

