



STRUCTURE ID: 204800

Ø2'-0" X 6'-0" Precast Concrete
Light Pole Base



Ø2'-0" X 6'-0" Precast Concrete Light Pole Base ... STRUCTURE ID : 204800

BASE 2,570 LBS.

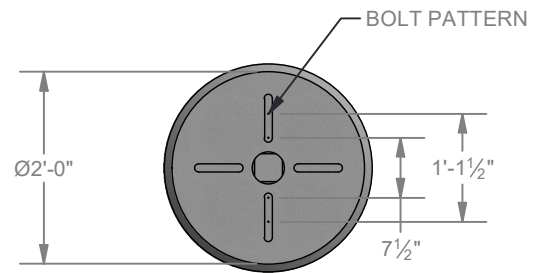
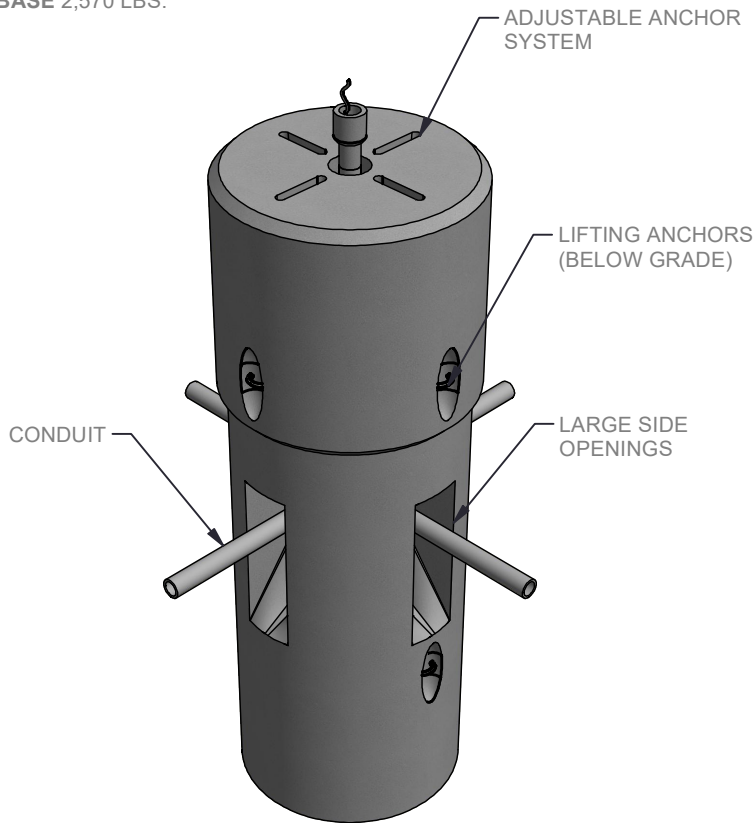

PLAN VIEW

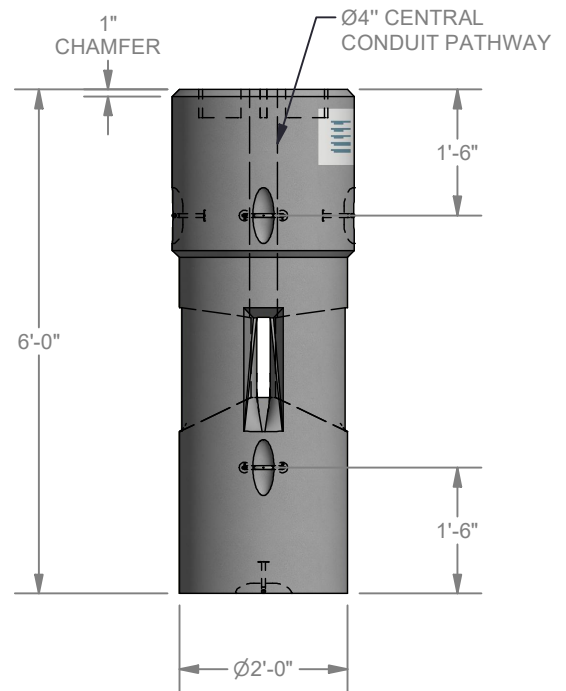

ELEV. VIEW

STANDARD LIGHT POLE BASE FEATURES

- Fast, Easy, and Efficient Installation
- Unique Universal Features to Meet Your Project Needs
- Anchor Bolt Circle Diameters From 7 1/2" Up to 13 1/2"
- Able to Accomodate Multiple Conduits From All Directions
- Large Side Openings Leading to A Central Vertical Pathway
- Engineered and Tested



LOCKE
SOLUTIONS

PROUDLY BASED IN
HOUSTON, TEXAS

T : 832-804-7062
F : 832-804-7071
E : info@lockesolutions.com

LOCKESOLUTIONS.COM